

Pressure Transmitter



- Ceramic/thick film measurement cell
- Two-wire version for 4... 20 mA output
- Compact, stable construction for the highest operational reliability

Type 8316 can be combined with...



Type 8611

Universal Controller
eControl



Type 8802-GD

Continuous
SideControl system



Type 8619

Multifunction
transmitter/controller

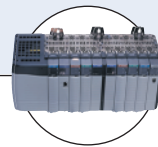

PLC

The compact Type 8316 pressure transmitter meets the highest requirements with regard to mechanical loading, EMC characteristics and operational reliability and is particularly suitable for demanding industrial applications. For aggressive fluids against stainless steel the process connection in PVDF is available.

General data	
Body material	Stainless steel 1.4404 (316L)
Wetted parts materials	Ceramics (Al ₂ O ₃), stainless steel 1.4404, FKM seal (for pressure 0 - 100 bar, only stainless steel 1.4404, no FKM seal, no ceramics)
Electrical connection	Round male connector M12x1
Process connection	G 1/4" external to DIN 3852 Form E NPT 1/4" external
Installation	As required, preferably with pressure connection in downward position
Measurement technology	Ceramic or thick film
Measurement procedure	Relative pressure measurement
Measuring range	0 to 1, 4, 6, 10, 16, 40 or 100 bar (0 to 14.51, 58.04, 87.06, 145.1, 232.16, 580.4, 1451 PSI)
Overload, bursting pressure	3 x full scale at 0... 4 bar (0... 58.04 PSI) 2.5 x full scale at 6... 100 bar (87.06... 1451 PSI)
Fluid temperature	-15 to +125°C (5 to 257°F)
Accuracy	Sum of linearity, hysteresis and reproducibility, balancing accuracy of zero point and full scale: ≤ 0.5% of F.S.*
Resolution	0.1% of F.S.
Dynamic response	Suitable for static and dynamic measurements response time < 2 ms, typ. 1 ms



* F.S. = full scale

Electrical data	
Operating voltage (U)	7 to 33 V DC, unregulated
Output signal	Standard 4... 20 mA (two-wire) or 0... 10 V DC (three-wire) signal
Load in Ω	$< (U - 7 \text{ V}) / 0.02 \text{ A}$
Protected connection	Short-circuit proof & protected against reverse polarity
Environment	
Ambient temperature	-15 to + 85°C (5 to 185 °F)
Temperature coefficient	< 0.2% of F.S.* / 10K
Standard and approvals	
Protection class	IP67
EMC	EN 61326-2-3
Approval	CE; UL-Recognized for US and Canada (UL61010-1 + CAN/CSA-C22 No.61010-1) 
Test/Admissions	
Shock acc. EN 60068-2-27	25g, 6 ms half sine wave, all three directions.
Drop test acc. EN 60068-2-23	from 1 m on concrete
Vibration acc. EN 60770-1	50m/s, 10... 1000 Hz, 1 Octave/min, 20 constant load per axis

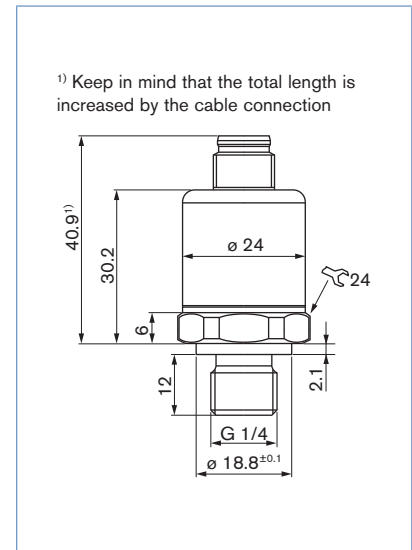
Dimensions [mm]



Ordering chart for pressure transmitter Type 8316

Process connection	Pressure range	Operating voltage	Output signal	Electrical connection	Item no.
G 1/4" UL-Recognized for US and Canada 	0 - 1.00 bar	7... 33 V DC	4... 20 mA	M12 male connector	563 777
	0 - 4.00 bar	7... 33 V DC	4... 20 mA	M12 male connector	563 778
	0 - 6.00 bar	7... 33 V DC	4... 20 mA	M12 male connector	563 779
	0 - 10.0 bar	7... 33 V DC	4... 20 mA	M12 male connector	563 780
			0... 10 V DC	M12 male connector	563 784
	0 - 16.0 bar	7... 33 V DC	4... 20 mA	M12 male connector	563 781
	0 - 40.0 bar	7... 33 V DC	4... 20 mA	M12 male connector	563 782
	0 - 100.0 bar	7... 33 V DC	4... 20 mA	M12 male connector	563 783
NPT 1/4" UL-Recognized for US and Canada 	0 - 60 PSI	7... 33 V DC	4... 20 mA	M12 male connector	564 466
	0 - 150 PSI	7... 33 V DC	4... 20 mA	M12 male connector	564 467
	0 - 300 PSI	7... 33 V DC	4... 20 mA	M12 male connector	564 468

 Further versions on request

 **Pressure**
other measuring ranges

 **Port connection**
NPT 1/4", ...

 **Electrical connection**
connectors: mini DIN, DIN ...

 **Additional**
electrical outputs: 0 - 10 V DC, 0 - 5 V DC

 **Materials**
EPDM seal, PVDF process connection

Ordering chart accessories

Description	Item no.
5-pin M12 female cable connector with plastic threaded locking ring	917 116
5-pin M12 female connector moulded on cable (2 m, shielded)	438 680

*To find your nearest Bürkert office, click on the orange box →

www.burkert.comIn case of special application conditions,
please consult for advice.Subject to alteration.
© Christian Bürkert GmbH & Co. KG

1505/5_EU-en_00895224