

Conductivity sensor



- Compact version for DN15 to DN200
- Large capabilities of conductivity measurement through different cells
- Large range of process connections with various fittings

Type 8220 can be combined with...



Type S020
INSERTION fitting



Type 8619
Panel-mounted multiCELL transmitter/controller



Type 8619
Wall-mounted multiCELL transmitter/controller

The conductivity sensor is a compact probe with integrated conductivity electrodes. Four conductivity probes having different cell constants are available and offer a large measurement range. The Pt1000 for automatic temperature compensation is integrated in the sensor housing.

The sensor transmits directly an analog signal and is fitted with a standard EN 175301-803 plug connector.

The sensor has to be connected to the Bürkert conductivity transmitter Type 8225 for panel or wall mounting or to the multiCELL transmitter/controller Type 8619 via a shielded cable (maximal cable length of 10 m).

The conductivity sensor can be installed into a pipe by using INSERTION fitting Type S020 which is available in different materials (details see data sheet Type S020). In its longer version it can also be installed in tanks or containers by using an industrial immersion fitting.

General data		Type 8619
Compatibility	Panel-mounted transmitter/controller	With fittings S020 (see corresponding data sheet)
Materials	Housing Screws Cable plug Wetted parts materials Fitting	PC Stainless steel PA Brass, Stainless steel 1.4404/316L, PVC, PP or PVDF
	Sensor holder Pt1000 Seal	PVDF Stainless steel 1.4571 (316Ti) FKM (EPDM included in delivery)
Electrode		Stainless steel for cell constant C = 0.01 or 0.1 Graphite for cell constant C = 1.0 or 10
Electrical connection		Cable plug EN 175301-803
Complete device data (fitting + sensor)		
Pipe diameter		DN15 to DN200
Conductivity measurement	Measuring range Accuracy	0.05 µS/cm ... 200 mS/cm (depending on cell constant) typical: 3% o. MV.* - max.: 5% o. MV.*
Temperature measurement	Measuring range Resolution Accuracy For temperature compensation	-50 to +150°C 0.1°C ± 1°C automatic (integrated Pt1000) - reference temperature 25°C
Medium temperature		With fitting in PVC: 0...+50°C (32 to 122°F) - PP: 0...+80°C (32 to 176°F) - PVDF, stainless steel, brass: 0...+100°C (32 to 212°F)
Fluid pressure max.		PN10 (see pressure / temperature chart)

* o. MV. = of measured value

Electrical data	
Power supply	none
Connection cable (between 8220 and remote 8225 or 8619)	4 x 0.2... 1.5mm ² shielded, max. length 10 m
Output	Analog signal, to be connected to remote electronic module Type 8225 or Type 8619
Environment	
Ambient temperature Operation and storage	0 to +60°C (32 to 140°F)
Relative humidity	≤ 80 %, without condensation
Standards, directives and approvals	
Protection class acc. to EN 60529	IP65 with cable plug mounted and tightened
Standard and directives	EN 61000-6-3 (2001), EN 61000-6-2 (2001) EN 61010-1 (2001) Complying with article 3 of §3 from 97/23/CE directive.* EN 60068-2-6 EN 60068-2-27

* For the 97/23/CE pressure directive, the device can only be used under following conditions (depend on max. pressure, pipe diameter and fluid).

Type of fluid	Conditions
Fluid group 1, §1.3.a	DN25 only
Fluid group 2, §1.3.a	DN ≤ 32 or DN > 32 and PN*DN ≤ 1000
Fluid group 1, §1.3.b	DN ≤ 200
Fluid group 2, §1.3.b	DN ≤ 200

Materials view

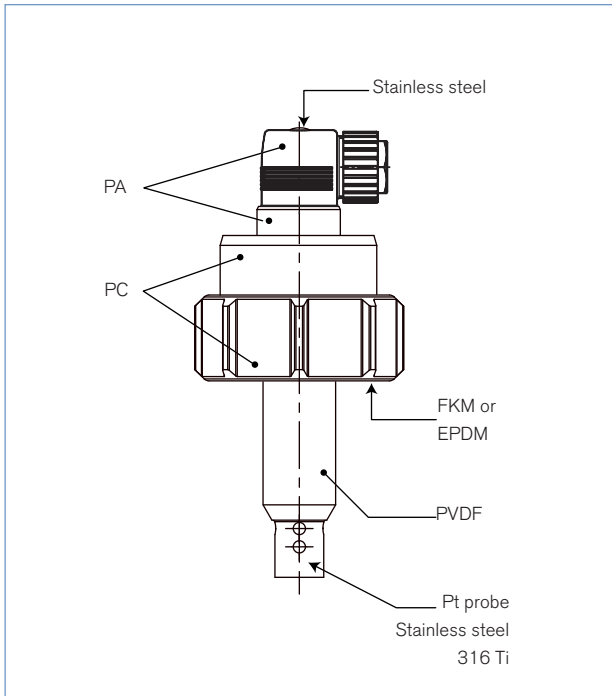

Pressure / temperature chart

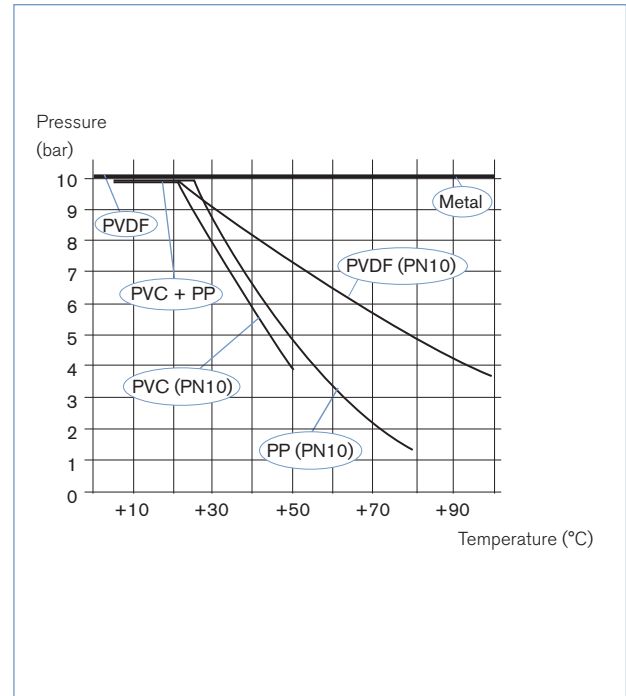

Principle of operation - Electrodes measuring range

Conductivity is defined as the ability of a solution to conduct electrical current. The load carriers are ions (E.G. dissolved salt or acids). In order to measure conductivity, 2 electrodes are used which are set at a fixed distance apart and with a known specified surface. An AC voltage source from the connected transmitter Type 8225 or transmitter/controller Type 8619 is supplied to the electrodes. The measured current is a direct function of the conductivity of the solution.

A 4... 20 mA standard signal proportional to the conductivity is available as output signal at the connected transmitter.

Different electrode designs are required based on selected cell constant.
The conductivity transmitter can be fitted with 4 different measuring cells with constants $C = 0.01; 0.1; 1$ and 10 .

The cell is selected according to the measuring range and medium by using the table below.

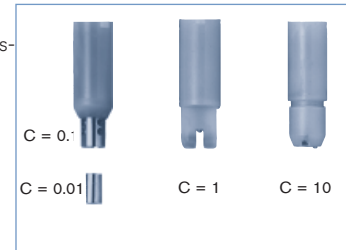
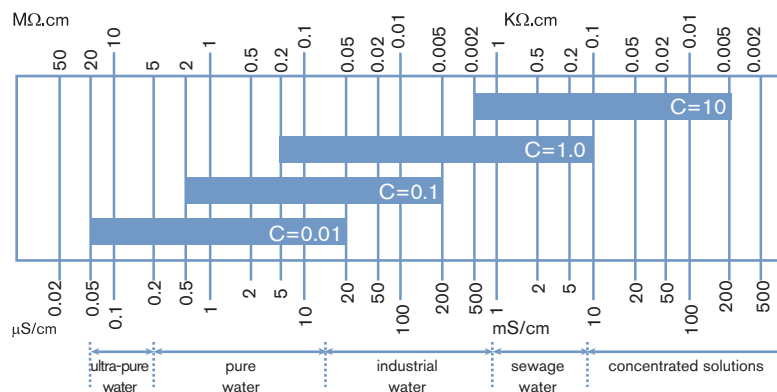

Installation

The compact conductivity sensor 8220 can be installed into any Bürkert INSERTION fitting (S020).

Select and install the required fitting onto the pipe, according to specific requirements of the sensor and fitting material (temperature and pressure). Then cautiously install the unit on the fitting and tighten with the nut.

With a cell constant $C = 10$, the opening hole of the small channel must be located on the flow inlet side.

The sensor can be installed in any position. In order to get a reliable measurement, air bubbles must be avoided and the mounting location must ensure that the electrode is continuously and completely immersed in the flow stream.

The transmitter must be protected from constant heat radiation and other environmental influences, such as direct exposure to sunlight.

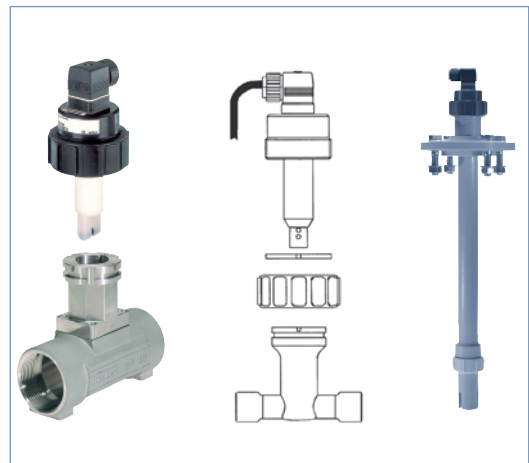

An industrial immersion kit allows installation of the **longer version of the sensor** having a cell constant $C = 0.01; 0.1$ or 1 into tanks or containers. The following lengths are available: 500, 1500, 2000 mm. Special lengths on request.

Dimensions [mm]

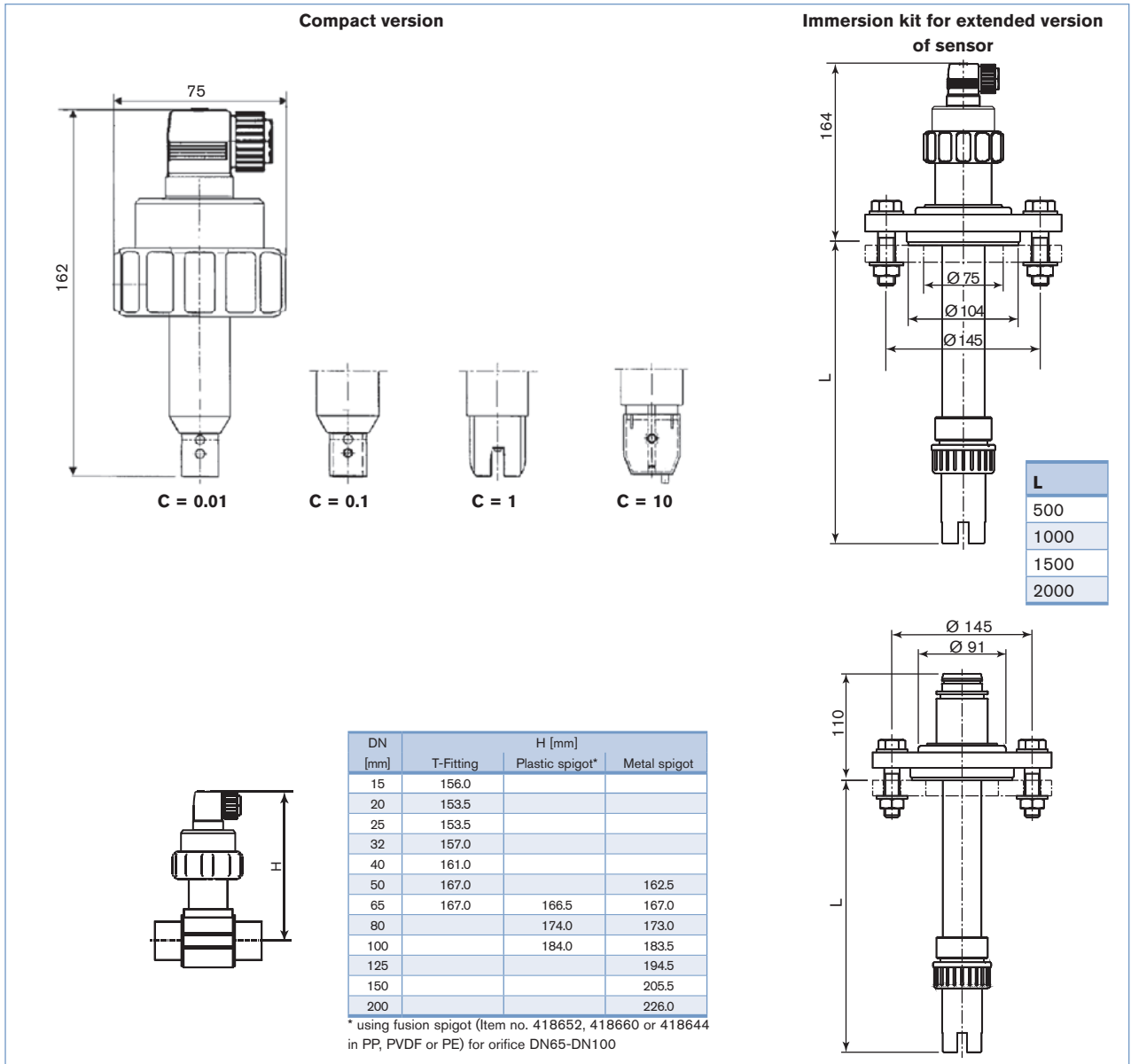

Combining the conductivity sensor Type 8220 with fittings Type S020

Available fitting DN	T-fitting S020	DN15	DN65	
	Welding tab S020		DN50	DN200
	Fusion spigot S020		DN65	DN100
Conductivity measurement 8220		DN15	DN32	DN200

Note A: Only use plastic fitting **in analytical version** with true union acc. to DIN 8063 (PVC), to DIN 16962 (PP) or to ISO 10931 (PVDF), see data sheet Type S020

Ordering information for a complete conductivity measurement equipment

A complete conductivity measurement equipment consists of a conductivity sensor Type 8220, a remote conductivity transmitter Type 8225 or a multi-CELL transmitter/controller Type 8619 and a Bürkert INSERTION fitting Type S020.

The following information is necessary for the selection of a complete device:

- **Item no.** of the desired conductivity sensor **Type 8220** (see ordering chart, below)
- **Item no.** of the desired conductivity transmitter **Type 8225** (wall-mounted or panel-mounted version - see separate data sheet) or multiCELL transmitter/controller **Type 8619** (see separate data sheet) [More info.](#)
- **Item no.** of the selected INSERTION fitting **Type S020** (DN15 - DN200 - see separate data sheet) [More info.](#)

When you click on the orange box "More info.", you will come to our website for the resp. product where you can download the data sheet.

→ You have to order three components.

Ordering chart for conductivity sensor Type 8220

Specifications	Measuring range	Cell constant	Electrode materials	Electrical connection	Item no.
Sensor	0.05 µS/cm ... 20 µS/cm	C = 0.01	Stainless steel	EN 175301-803	426 872
	0.5 µS/cm ... 200 µS/cm	C = 0.1	Stainless steel	EN 175301-803	426 873
	5 µS/cm ... 10 mS/cm	C = 1	Graphite	EN 175301-803	426 874
	0.5 mS/cm ... 200 mS/cm	C = 10	Graphite	EN 175301-803	426 875

Ordering information for tank installation

Tank installation with a conductivity sensor Type 8220 in an longer version.

A conductivity sensor Type 8220 for tank installation is made up of a conductivity probe, an immersion kit which is consisting of an immersion fitting, an extension cable kit for immersion fitting, a fixing kit (flange DN65 with stainless steel screws) and has to be connected to a remote conductivity transmitter Type 8225 or a multiCELL transmitter/controller Type 8619.

The following information is necessary for the selection of a complete device:

- **Item no.** of the desired conductivity probe** (see accessories ordering chart on p. 6)
- **Item no.** of the immersion fitting (see accessories ordering chart on p. 6)
- **Item no.** of the extension cable kit for the immersion fitting (see accessories ordering chart on p. 6)
- **Item no.** of the fixing kit (flange DN65 with stainless steel screws: see accessories ordering chart on p. 6)
- **Item no.** of the desired conductivity transmitter **Type 8225** (wall-mounted or panel-mounted version - see separate data sheet) or multiCELL transmitter/controller **Type 8619** (see separate data sheet) [More info.](#)

→ You have to order five components.

<p>Remote conductivity transmitter Type 8225</p> <p>or</p> <p>multiCELL transmitter/controller Type 8619</p>	<p>Immersion fitting</p>	<p>Extension cable kit</p>	<p>Fixing kit</p> <p>Conductivity probe**</p>
--	---------------------------------	-----------------------------------	---

** For the tank installation only probes with cell constant C=0.01, 0.1 or 1 are available

Ordering chart for accessories for conductivity sensor Type 8220

Description	Item no.
Set with 2 cable glands M20x1.5 + 2 neoprene flat seals for cable gland or plug + 2 screw-plugs M20x1.5 + 2 multiway seals 2x6 mm	449 755
Cable plug EN 175301-803 with cable gland (Type 2508)	438 811
Cable plug EN 175301-803 with NPT1/2 " reduction without cable gland (Type 2509) - UR and UL approval	162 673
Mounting ring (open) for S020 fitting	619 205
PC - nut	619 204
Set with 1 green FKM + 1 black EPDM seal	552 111
Conductivity probe C = 0.01 (with stainless steel electrode) for mounting with immersion kit	633 367
Conductivity probe C = 0.1 (with stainless steel electrode) for mounting with immersion kit	631 647
Conductivity probe C = 1 (with graphite electrode) for mounting with immersion kit	418 217
Immersion fitting in PP, L = 0.5 m	419 567
Immersion fitting in PP, L = 1.0 m	419 568
Immersion fitting in PP, L = 1.5 m	419 569
Immersion fitting in PP, L = 2.0 m	419 570
Extension cable kit including a 0.7 m cable (for immersion fitting, L ≤ 0.5 m to use with 8225 remote transmitter or with 8619 multiCELL transmitter/controller)	437 615
Extension cable kit including a 1.7 m cable (for immersion fitting, L ≤ 1.5 m to use with 8225 remote transmitter or with 8619 multiCELL transmitter/controller)	437 617
Extension cable kit including a 2.2 m cable (for immersion fitting, L ≤ 2.0 m to use with 8225 remote transmitter or with 8619 multiCELL transmitter/controller)	437 618
Fixing kit (flange DN65 with stainless steel screws)	413 615
Factory 2-point conductivity calibration certificate	550 675

Interconnection possibilities with other Bürkert devices

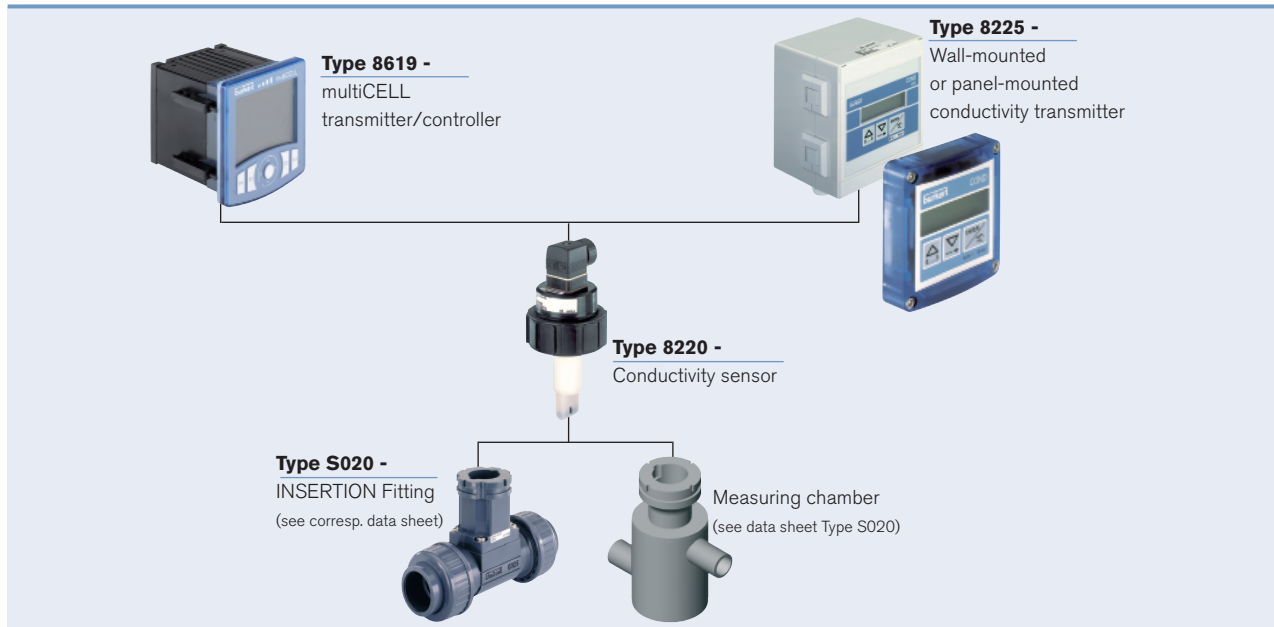

To find your nearest Bürkert facility, click on the orange box →

www.burkert.com

In case of special application conditions, please consult for advice.

Subject to alteration.
© Christian Bürkert GmbH & Co. KG

1506/4_EU-en_00895157

DTS 1000141283 EN Version: D Status: RL (released | freigegeben | valide) printed: 28.07.2015